



INSTALLATION GUIDE



AXISS RAIN HEAD CEILING MOUNTED (180MM)

SYSTEM REQUIREMENTS

To ensure the optimum performance and customer satisfaction please adhere to the following:

- Flush out all pipe work prior to installation.
- Installation should comply with relevant local authority requirements.

	MINIMUM	MAXIMUM
Operating pressures	35kPa (5.1psi)	500kPa (72.1psi)
Operating Hot Water Temperatures	55°C	60°C
Operating Cold Water Temperatures	5°C	N/A

Failure to comply with the above will void all warranties.

AS/NZS 3500.1 states that pressures above 500kPa can cause damage from water hammer, reduce the life of appliances, taps & fittings, cause excessive noise in the system and recommend that a pressure limiting valve (PLV) be fitted.

WHATS IN THE PACK

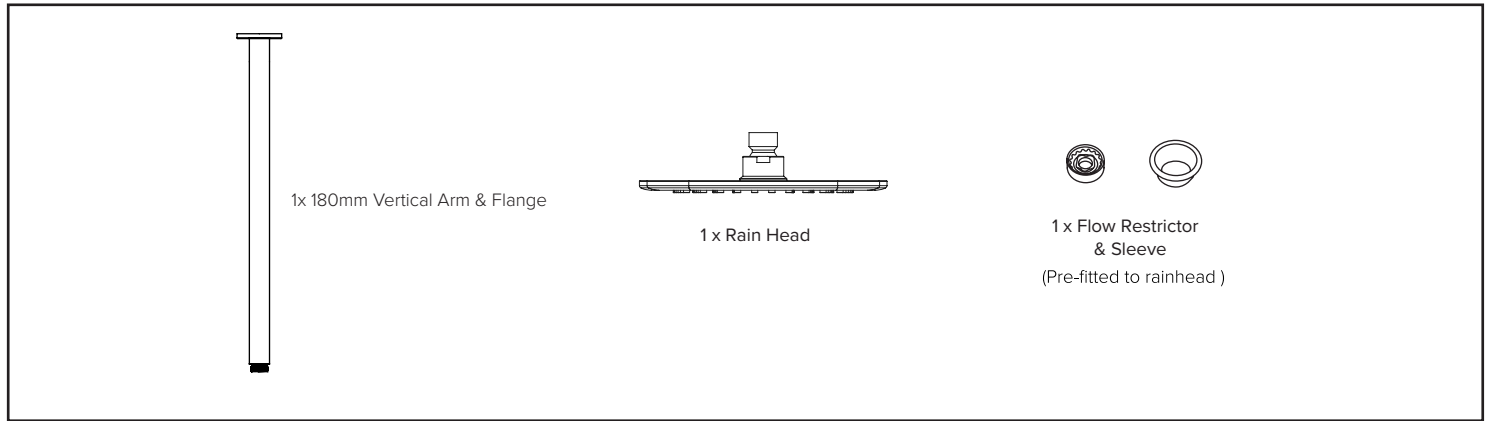

Warranty, Maintenance and Care YOUR COPY TO KEEP



Felton Industries Limited guarantees these products to be free from defects in materials and workmanship for a period of five (5) years from the date of purchase. This warranty is effective for 5 years from the date of purchase and covers supply of replacement parts only, not including installation. You must retain proof of purchase of the product (such as an invoice or receipt) and provide this to Felton on request. This warranty is for manufacturing defects only and does not cover any damage to product due to abuse, negligence or improper installation. This warranty is given on the understanding that the product is installed and operated according to Felton's installation guide and the Australian/New Zealand standard AS/NZS3500. This warranty is provided to persons who are a "consumer" under the Consumer Guarantees Act 1993 only and for use in domestic/residential dwellings only (not for commercial use).

At no stage should plated surfaces be cleaned with cleaning agents that contain a corrosive acid or a scouring additive. Plated surfaces should be cleaned with liquid detergent or soap and water. Any damage caused through the use of an unsuitable cleaner will not be covered by warranty. This warranty is subject to any other rights or remedies that you may have under the Consumer Guarantees Act 1993 (or any other applicable legislation) and to Felton's Terms of Trade.

Please fill in the details below, attach your receipt to this installation guide and keep as your proof of purchase.

Purchased at:

Date of purchase:

Installed by:

For technical assistance please ring: 0800 743 358 or (09) 528 0810

HOW TO INSTALL

INSTALLING INTO STUD/NOG... (RECOMMENDED)

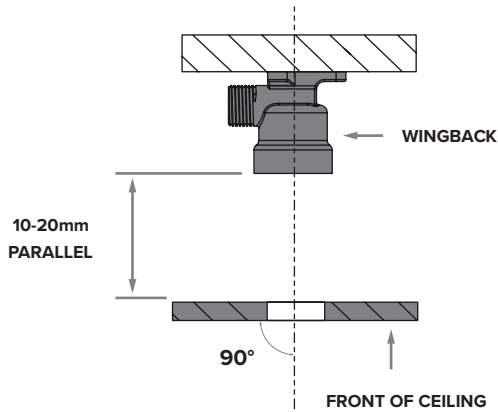

1. Ensure the wingback when fitted is parallel and square to the ceiling lining as shown.

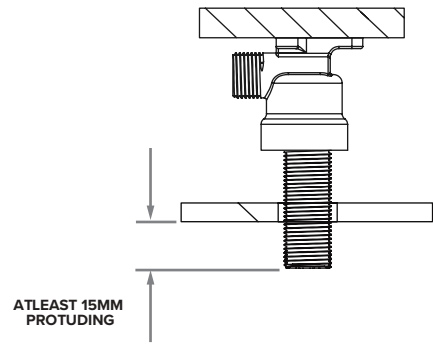

2. Cut and fit 1/2" BSP with atleast 15mm protuding from the finished wall. Use seal tape when threading into wingback.

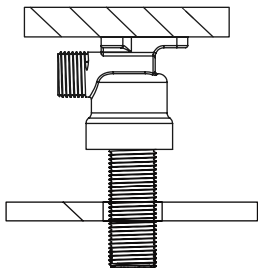

3A. Apply seal tape to exposed 1/2" BSP and then thread arm onto 1/2" until flush with wall and aligned.

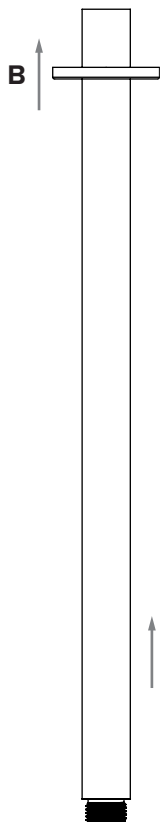

3B. Apply silicone to underside of flange and fit until contact on wall.

4. Flush supply lines.

5. **FOR MAIN PRESSURE**
Fit as supplied.

FOR LOW PRESSURE
Remove rubber mesh filter and remove the flow restrictor and sleeve. Refit the rubber mesh filter and then screw rain head onto the arm.

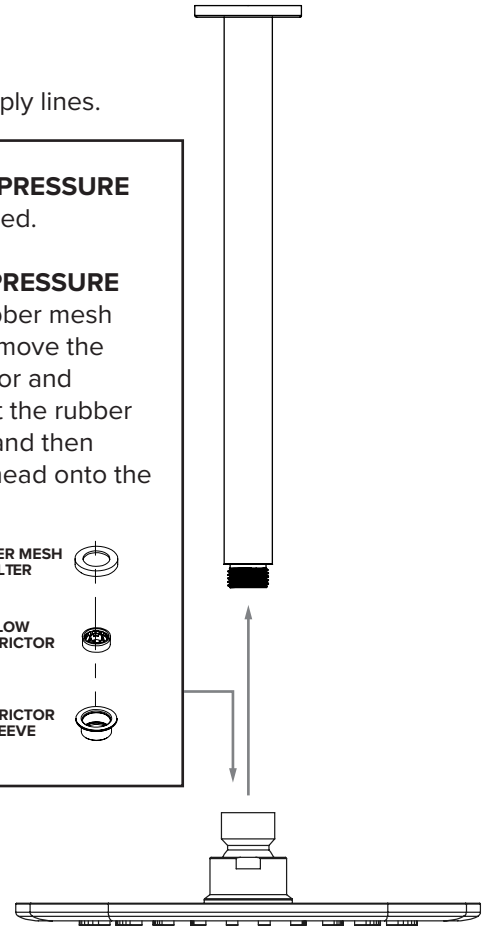
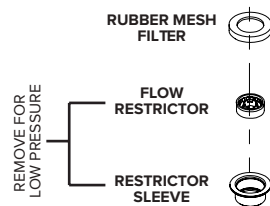

6. Turn on water supply and check for leaks.